

The logo for Motosel Industrial Group features the word "Motosel" in a bold, white, sans-serif font. The letter "o" is highlighted in red. To the left of the text is a stylized graphic of three horizontal lines of varying lengths, suggesting motion or speed. Below the main name, the words "INDUSTRIAL GROUP" are written in a smaller, white, all-caps sans-serif font.

**Motosel**  
INDUSTRIAL GROUP

INDUSTRIAL LUBRICANTS

## TABLE OF CONTENTS

- 2 ABOUT US
- 3 INTRODUCTION
- 6 HYDRAULIC OIL
- 9 COMPRESSOR OIL
- 12 GEAR OIL
- 17 TURBINE OIL
- 21 WIND TURBINE OIL
- 25 ELECTROL OIL

- 1 TABLE OF CONTENTS

PROVIDING TOMORROW'S SOLUTION **TODAY**

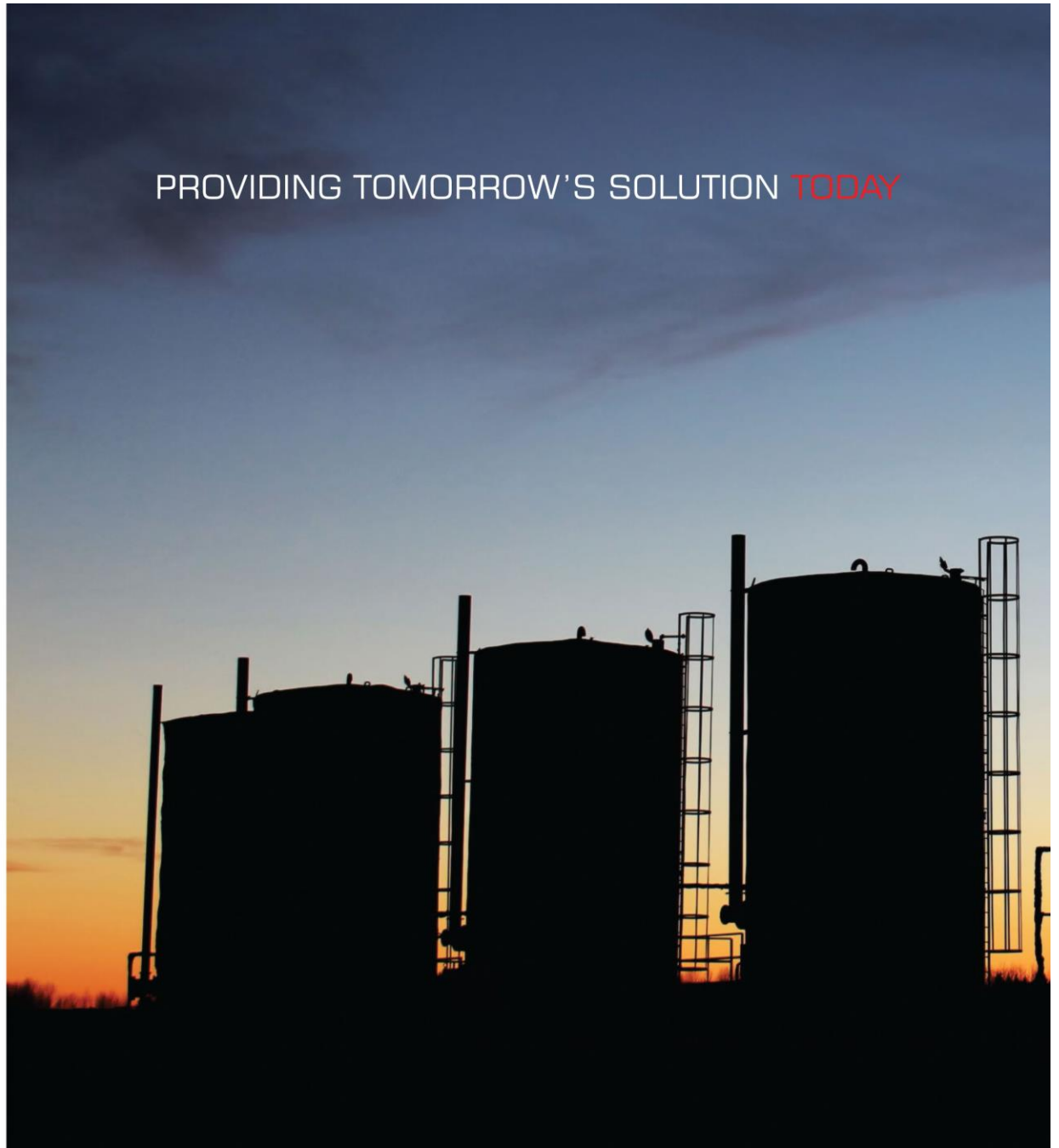



**Motosel Industrial Group Inc.** was established in 1987, as a manufacturer of industrial lubricant supplying major Steel , Oil & Gas, Petrochemicals, Textile, Mining and metal forming industries . It wasn't till year 2006 that company decided to introduce its own brand of automotive products and oil under Motosel brand.

Our core values of honesty, integrity and respect for people form the basis of the Motosel General Business Principles.

Providing high-quality and economical products through employing motivated,- flexible and dedicated teams to fulfil satisfactions of our customers' expectation has been continuously our primary objective. We value the importance of our relations and will continue to remain reasonable and honest with all employees, customers and partners.

Motosel Industrial Group aims to be a model enterprise by high standards of operations in producing and supplying its products. Motosel dynamic infrastructure offers the highest industrial products and essential management system which are supported by a great team of professionals using excessive technical resources,who has also experienced high sense of ownership and commitment within the organization.

## INTRODUCTION

### INDUSTRIAL OIL

Industrial lubricants are formulated with various base oils and special additives based on its specific purpose and application. Such products are widely utilized in different industries such as oil, gas & petrochemical, steel, cement, mining, power generation and so on. Therefore, vast majority of lubricants belong to these categories including full synthetic gear oils (PAO, PAG based), refrigeration and air compressor oils, regular and R&O hydraulic oils, fire-resistant hydraulic oils (HFDU, HFC), turbine oil, rubber processing oil, heat transfer oil, hot & cold rolling oil and so on.

When it comes to mention advantages of a reliable industrial lubricant, outstanding EP, anti-foaming, anti-corrosion, high viscosity index, oxidation and thermal stability properties are of major benefits of such industrial lubricant.

Utilizing high quality internationally approved additives, highly refined base oils and an advanced formula according to application of the lubricant create advantages in such a way that heat transfer systems, central lubrication systems and industrial equipment last longer.



### API CLASSIFICATION OF BASE OILS

Base oils are chemical materials with hydrocarbon structure utilized in industrial lubricants' formula and manufactured in two different methods namely chemical synthesis (synthetic base oil) and crude oil refining process (mineral base oil). Extracting lube cut from crude oil in huge refineries, the lube cut will be fed to base oil refineries to produce base oil.

American petroleum Institute (API) categorized base oils based on chemical, physical specifications in to 5 different groups. The first 3 groups of aforementioned classification are relevant to mineral base oils produced by crude oil refining processes. The last group namely group III has the highest quality and consequently has the highest performance amongst crude oil refined base oils. PAO base oils belong to the fourth group and are chemically synthesized. Notably, group III base oils are produced by severe hydrocracking and hydro-isomerization processes and most resembles to group IV base oils. Finally the group V includes Esters, glycols, naphthenic types and other base oils with different specifications with four former groups.

Refined from sweet crude oil distillates. Naphthenic base oils have a very low aromatic content and a low paraffin (Wax) content. These characteristics allow for a low pour point on lighter viscosities and a high degree of solvency where heavier viscosities are required.

Comparison table of different groups of base oils are presented below:

**Table 1- API Classification of base oils**

GROUP	SATURATES (%wt) (PARAFFINS & NAPHTHENES CONTENT)		SULPHUR (%wt)		VISCOSITY INDEX
I	<90	and/or	>0.03	and	80 < VI < 120
II	≥90	and	≤0.03	and	80 < VI < 120
III	≥90	and	≤0.03	and	> 120
IV	PAO's (Polyalphaolefins)				
V	All stocks not included in Groups I -IV and VI (Pale oils or Naphthenic and non-PAO synthetics such as esters, polyglycols...)				

In addition to conventional base oils spanning from group I to III, there are several other synthetic base oils such as: **Esterified oils / Phosphate esters / Synthesized hydrocarbons / PAO / Silicones / ...**

According to above mentioned types of lubricants, some special specifications of various synthetic base oils will be mentioned in the following:

### PAO

Polyalphaolefins are the most well-known type of synthetic base oils. Its chemical structure resembles to mineral base oils and is synthesized through polymerization of alphaolefin. A sample of chemical structure of this synthetic base oil is depicted below in figure 1.

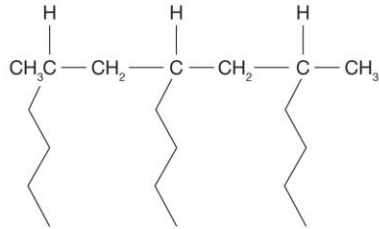

Figure 1 - Sample of chemical structure of PAO

### PAG

Polyalkylene glycols are synthesized through oxidation process of propylene and ethylene. One of major specifications of such base oil is outstanding EP property without relying on EP related additives. A sample of chemical structure of this synthetic base oil is depicted below in figure 2.

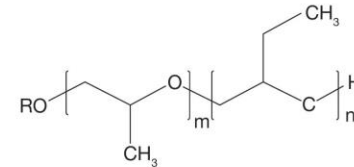

Figure 2 - Sample of chemical structure of PAG

### ESTERS

Esters are produced when carboxylic acids are heated with alcohols in the presence of an acid catalyst. Outstanding thermal stability in low and high temperatures are of main specifications of these type of base oils. A Sample of chemical structure of this synthetic base oil is depicted below in figure 3.

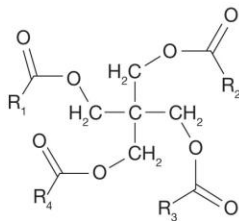

Figure 3 - Sample of chemical structure of ESTERS

### SILICONE OILS

This type of synthetic base oils are of inorganic polymers category and due to presence of high length chains in chemical structure, silicon elastomers will be formed and as a result, high performance in a wide thermal interval spanning from -73°C to 300 °C is of one of its major advantages. A Sample of chemical structure of this synthetic base oil is depicted below in figure 4.

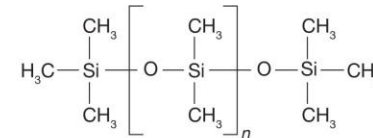

Figure 4 - Sample of chemical structure of Silicone oils

## WHY SYNTHETIC OIL?

Synthetic oils are mainly developed due to ineffectiveness of regular lubricants in modern applications. These types of oils are produced in a series of elaborated petrochemical processes using chemical raw materials. For Instance, in modern technologies these lubricants are extensively utilized according to special specifications such as: extremely low pour point, high viscosity index, viscosity-temperature behavior in boundary conditions, fire-resistant property and so on while mineral lubricants are not qualified for severe operational conditions. Besides, synthetic oils belong to group IV and V of API base oil classification. PAOs are the most resembling synthetic oils to mineral groups.

**Table 2 - physical-chemical properties of synthetic base oils**

PROPERTIES	MINERAL OIL	HT	PAO	ESTERS	PAG	SILICON	PFPE
Density@20°C, g/ml	0.9	0.85	0.85	0.9	0.9-1.1	0.9-1.05	1.9
Viscosity Index	80- 100	100- 120	130- 160	140- 175	150-270	190-500	50-140
Flash point °C	>200	>250	>200	200-230	150-300	150-350	Non flammable
Oxidation stability	medium	good	good	good	good	very good	excellent
Thermal stability	medium	good	good	good	good	very good	very good
Lubricity	good	good	good	good	excellent	poor	good
Compatibility with seals	good	good	good	poor	poor to good	good	good

### ADVANTAGES OF SYNTHETIC BASE OILS OVER MINERAL TYPE

Synthetic base oils are more beneficial than mineral ones from various viewpoints:

- Outstanding aging stability
- Excellent viscosity-temperature relationship
- Low volatility
- High flash point
- Low pour point
- High oxidation resistance
- Low Ash volumes

### CLASSIFICATION OF INDUSTRIAL LUBRICANTS' VISCOSITY GRADES

The viscosity of a fluid is a measure of its resistance to gradual deformation by shear stress or tensile stress. Such property of oil will be changed by temperature variations and oils in high temperatures will show lack of thickness. Viscosity of industrial oils are measured in 20°C, 40°C and 100°C.

Formerly, scientists were planning to set a standard method for determination of oil types so as to facilitate transformation of technical and commercial concepts. In essence this method was determined based on ISO in order to measure viscosity of oils in such a way that all designers, providers and manufacturers of various types of oils have the possibility of exchange standard information amongst their community. According to previous researches, the best temperature for formulation and classification of industrial lubricants and setting such standard point is 40°C. Therefore, this type of classification of ISO is based on kinematic viscosity of lubricants and as a result of set standard, authorized amount of oil's kinematic viscosity deviation from its mean value is 10%.

**Table 3 - ISO Classification of Industrial oils**

ISO VISCOSITY GRADE	MID-POINT VISCOSITY CST AT 40-00C	KINEMATIC VISCOSITY LIMITS CST AT 40-00C	
		MINIMUM	MAXIMUM
ISO VG 2	2-2	1-98	2-42
ISO VG 3	3-2	2-88	3-52
ISO VG 5	4-6	4-14	5-06
ISO VG 7	6-8	6-12	7-48
ISO VG 10	10	9-00	11-0
ISO VG 15	15	13-5	16-5
ISO VG 22	22	19-8	24-2
ISO VG 32	32	28-8	35-2
ISO VG 46	46	41-4	50-6
ISO VG 68	68	61-2	74-8
ISO VG 100	100	90-0	110
ISO VG 150	150	135	165
ISO VG 220	220	198	242
ISO VG 320	320	288	352
ISO VG 460	460	414	506
ISO VG 680	680	612	748
ISO VG 1000	1,000	900	1,100
ISO VG 1500	1,500	1,350	1,650

## HYDRAULIC OIL

### THE VISCOSITY TEMPERATURE RELATIONSHIP

The viscosity of lubricants changes with temperature. As temperature rises, viscosity decreases, and as temperature decreases, viscosity increases. A measure of the relative rate of change of viscosity with temperature is referred to as the fluid's Viscosity Index, or VI. Viscosity Index is an empirical, unit-less number used to quantify the change of viscosity with respect to temperature.

The viscosity of a fluid with high VI does not change as rapidly with temperature when compared with a lower VI fluid. For mineral hydraulic fluids, typical VI is between 90 and 110.

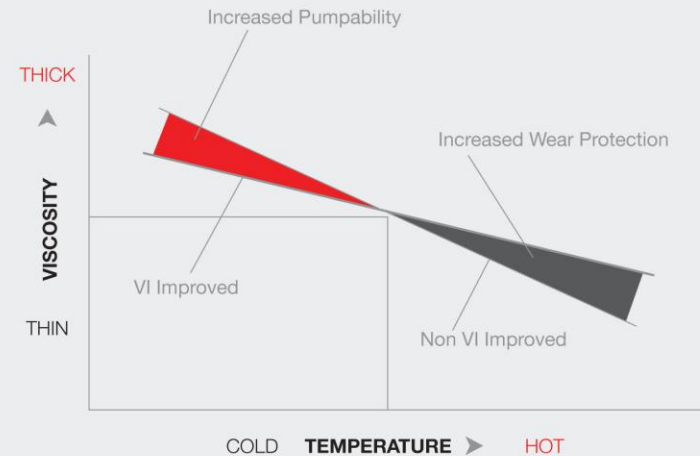

### SHEAR STABILITY MEASUREMENTS

There are three commonly used methods for determining the shear stability of a high VI fluid. DIN 51382 – The Bosch Injector Test is considered to be the least severe of these methods. The test oil is run through 250 cycles at 2550 psi and the change in viscosity is measured. ASTM D5621 – The Sonic Shear method functions by shearing the sample hydraulic fluid in a sonic oscillator for 40 minutes and the change in viscosity is measured. This test is favored by some USA OEMs, but is increasingly being replaced by the CEC L45-A-99 KRL Tapered Roller Bearing Test. CEC L45-A-99 – The KRL Tapered Roller Bearing test is becoming the test of choice of many OEM's around the world, as it is considered the most severe and offers the best correlation to actual field performance.

Test oil is run in a fitted tapered roller bearing for 20 hours under design load. Before and after viscosities are compared for percent viscosity loss. The graph below shows a 12.6% reduction in viscosity shear loss from a shear unstable oil to a shear stable oil as tested in the KRL Tapered Roller Bearing test.

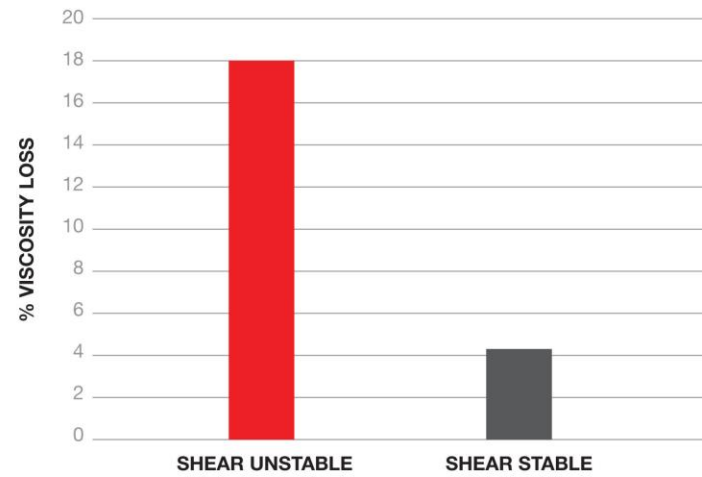

## HIDROL-ED

HIDROL-ED is a high performance multipurpose mineral hydraulic oil which is produced from high quality mineral base oils and several kinds of special additives.

### FEATURES AND BENEFITS

- Excellent protection against rust and corrosion
- Excellent shear stability and anti-corrosion performance
- Resistance to foam forming
- Excellent demulsibility properties

## PHYSICAL CHARACTERISTICS

TECHNICAL CHARACTERISTICS	TEST METHOD	22	32	46	68	100	150	220
ISO VG		22	32	46	68	100	150	220
Kinematic Viscosity @40°C, cSt	ASTM D-445	21±2	33±3	47±4	68±6	100±5	150±7	220±10
Brookfield Viscosity @-18°C, cP	ASTM D-2983	-	925	1378	2389	4510	-	-
Density @15.6°C, kg/m <sup>3</sup>	ASTM D-1298	880±50	880±50	880±50	880±50	880±50	880±50	880±50
Viscosity Index	ASTM D-2270	103	102	105	105	101	99	98
Copper Strip Corrosion, 3hrs@100°C	ASTM D-130	1b	1b	1b	1b	1b	1b	1b
Rust Characteristics	ASTM D-665B	PASS	PASS	PASS	PASS	PASS	PASS	PASS
FZG Gear Test, Failure Stage	DIN 51354	11	11	11	11	11	11	11
Flash Point, °C	ASTM D-92	200	210	216	225	236	240	244
Pour Point, °C	ASTM D-97	-30	-30	-27	-24	-21	-18	-15
Foam Sequence I, II, III, ml/ml	ASTM D-893	50/0	50/0	50/0	50/0	50/0	50/0	50/0
Demulsibility, @54°C, Minutes to 3 ml emulsion (Max)	ASTM D-1401	20	20	20	20	20	-	-
Demulsibility, 82°C, Minutes to 3 ml emulsion	ASTM D-1401	-	-	-	-	-	20	20

Test Method ASTM - Typical test data are average values only. Minor variations, which do not affect performance, may occur.

Notice: Above specifications can be adjusted to customer's request

## HIDROL-S

HIDROL-S is a high performance multipurpose Full Synthetic oil which is produced from high quality base oils and several kinds of special additives.

### FEATURES AND BENEFITS

- Outstanding protection against rust and corrosion
- Extra long life and energy saving
- Excellent filtration properties
- Excellent oxidation resistance
- Resistance to foam forming
- Excellent shear stability and anti-corrosion performance
- Enhanced anti-wear protection and improved pour point & VI
- Superior demulsibility properties

## PHYSICAL CHARACTERISTICS

TECHNICAL CHARACTERISTICS	TEST METHOD	22	32	46	68	100	150	220
ISO VG		22	32	46	68	100	150	220
Kinematic Viscosity @40°C, cSt	ASTM D-445	22±1	32±2	46±2	68±3	100±5	150±7	220±10
Viscosity Index	ASTM D-2270	>160	>160	>160	155	130	120	120
Brookfield Viscosity @-20°C, cP	ASTM D-2983	-	1095	1875	3995	11245	-	-
Brookfield Viscosity @-20°C, cP	ASTM D-2983	-	3360	7060	16380	57800	-	-
Brookfield Viscosity @-20°C, cP	ASTM D-2983	6395	14245	55771	-	-	-	-
Tapered Roller Bearing %Viscosity Loss	CEC L-45-A-99	5	5	7	11	7	7	-
Density @15.6°C, kg/m <sup>3</sup>	ASTM D-1298	880±40	880±40	880±40	880±40	880±50	880±50	880±50
Copper Strip Corrosion, 3hrs@100°C	ASTM D-130	1b	1b	1b	1b	1b	1b	1b
FZG Gear Test, Failure Stage	DIN 51354	-	12	12	12	12	12	12
Flash Point, °C	ASTM D-92	>220	>240	>230	>235	>250	>255	>255
Pour Point, °C	ASTM D-97	-54	-54	-45	-39	-33	-30	-30
Foam Sequence I, II, III, ml/ml	ASTM D-893	20/0	20/0	20/0	20/0	20/0	20/0	20/0
Acute Aquatic Toxicity (LC-50, OECD 203)		PASS	PASS	PASS	PASS	PASS	PASS	PASS

Test Method ASTM - Typical test data are average values only. Minor variations, which do not affect performance, may occur.

Notice: Above specifications can be adjusted to customer's request



## CLEANLINESS OF HYDRAULIC OIL

It is widely accepted that particle contamination reduces the service life of hydraulic components. Fact is, some level of particle contamination is always present in hydraulic fluid, even in new fluid. The level of contamination or conversely, the level of cleanliness considered acceptable, depends on the type of hydraulic system. NAS value of the product is in range of 7 to 8 which can be more customized based on customer's request.

## LIFE CYCLE

Laboratory testing demonstrates the feature offered by these new fluids . In industry -accepted pump tests, many widely used fluids show varnish formation within 500 hours of beginning operation. Compare that to the results found in the new additive technology solution to the age-old varnish problem : even after 1,000 hours of use , there is no evidence of varnish formation.

## FIELD OF APPLICATIONS

- Industrial hydraulic systems.
- Mobile hydraulic fluid power transmission systems.
- Marine hydraulic systems.
- Severe duty hydraulic service.
- Mobile /exterior hydraulic applications.
- Precision hydraulic systems.
- Manufacturing and industrial hydraulic systems.
- Severe duty hydraulic service.
- Construction hydraulics
- Mining hydraulics
- Marine hydraulics
- Forestry hydraulics
- Agricultural hydraulics
- Industrial hydraulics
- Oil & gas hydraulics



INNOVATIVENESS  
RELIABILITY  
EFFECTIVENESS

## COMPRESSOR OIL

### COMPRESSOR BASICS

There are many types of compressors, including rotary screw, rotary vane, reciprocating and centrifugal compressors. Rotary screw compressors represent around ¾ percent of the industrial market for compressors.

All compressors basically work in the same manner as a rotary screw compressor (see diagram below) to increase gas pressure by reducing its volume, there fore delivering pressure energy.

### BASIC COMPRESSOR SYSTEM DIAGRAM

- Oil is injected into the compression chamber
- The oil-air mixture is discharged (oil vapor and oil aerosols in the compressed air)
- The oil separator removes the oil aerosols out of the air stream
- Compressed air leaves through the oil separator, cooler and filter

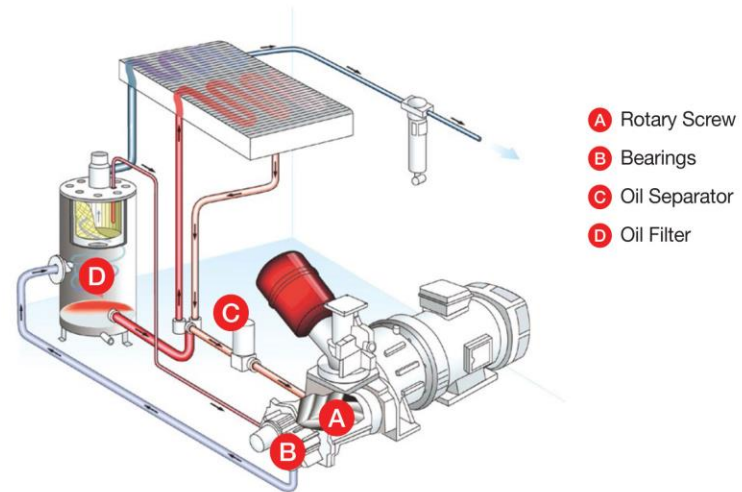

### MOTOSSEL SYNTHETIC HELPS SAVE ENERGY

Energy constitutes a major factor in air compression operating costs. With the use of suitable synthetic oils, energy costs can be totally reduced. Since the right synthetic compressor oil reduces friction in the compressor and offers a better gap sealing effect, volumetric efficiency might be increased while reducing energy consumption. Power consumption of a compressor per compressed volume under standardized conditions were inspected. The results speak for themselves when comparing the power consumption rate for a conventional mineral oil versus that attained with motosel VDLS.

Typical cost shares in compressor operation. choosing the right oil can lead to significant savings although less than one percent is spent on the compressor oil.

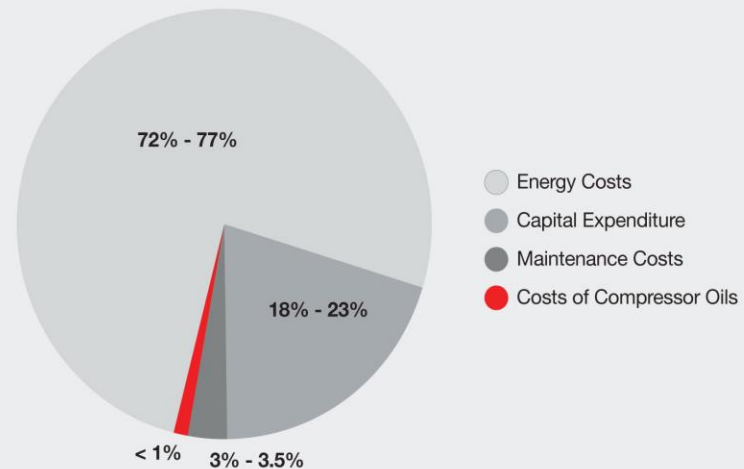

## EQUIPMENTS

Excess wear can seriously compromise an air compressor's life and efficiency. The Motosel industrial lubricants range includes dedicated rotary compressor oils designed to control vane and screw wear, and oils for reciprocating compressors specifically to control cylinder, piston-ring and valve wear.

### ACCORDING TO BASE OIL TYPE...

Polyglycols are blend of Glycol fluid and esters generally POE's. It is quite heavy having the density close to water. Being heavy gives it superior heat transfer capabilities. It is also a self cleaning oil. It is generally not compatible with most other oils. Inadvertent topping off with the wrong oil can result in a air end failure. Service life is typically 8-10000 hours. Diester based lubricants were the first synthetics introduced to be used in rotary screw air compressors. When properly formulated it can give 8000 hours operation. It is a self cleaning oil.

PAO's were introduced shortly thereafter. They offer 6-8000 hours operation. However if they are run beyond their service life, the deposits left after the oil change will shorten the service life of the fresh oil charge. After several oil changes PAO's can have service life as short as 1000 hours. If you find varnish deposits in a compressor using PAO's use a flush oil to get to your full service life. All Food Grade air compressor oils are PAO's and have about 1/2 the service life of other PAO's because of the limited number of additives that are available.

## COMPRESSOR TYPES

### RECIPROCATING COMPRESSOR

In a reciprocating compressor a gas is compressed in a cylinder under a moving piston. Intake and release of the gas (air) is controlled by inlet and discharge valves (similar to the internal combustion engine). There are two lubrication systems in reciprocating compressors: cylinder lubrication and crankcase lubrication. Cylinder lubrication provides oil to pistons, piston rings, cylinder liners, cylinder packing and valves. Crankcase system lubricates cross-head guides, main bearings, wristpins, crankpins and cross-head pin bearings. Both lubrication systems are commonly lubricated by mineral oils from the viscosity range ISO VG 68 to ISO VG 220 containing Corrosion inhibitors, anti-oxidants and anti-wear additives. Higher viscosity indexes are used for higher temperatures. For some applications synthetic lubricants of equivalent viscosity indexes (diester, polyglycol, polyolester or phosphate ester) are recommended. Hydrocarbon lubricant (mineral and synthetic) are never used for compressing active gases (hydrogen chloride, oxygen).

### SCREW (HELICAL LOBE) COMPRESSOR

Helical lobe screw compressor consists of two rotors mounted in a housing. When the rotors rotate they compress air between helical lobes. The compressed gas is in contact with the compressor lubricant that may cause its oxidation. Screw (helical lobe) compressors are commonly flooded lubricated either by mineral oils of viscosity grades ISO VG 32, ISO VG 46 or ISO VG 68 with rust and oxidation preventive additives (R&O) or by synthetic based oils of equivalent viscosity indexes (polyalphaolefin, polyolester, diester or polyglycol). Oil free (dry type) screw compressors utilize timing gear. The gear and the bearings are lubricated with an oil from the viscosity range ISO VG 32 to ISO VG 100 (depending on ambient temperature and application).

### SLIDING VANE COMPRESSOR

Sliding vane compressor utilizes centrifugal force of a rotating vane mounted eccentrically in a cylinder. Sliding vane compressors are commonly flooded or injection lubricated. The compressed gas pressure is about 150 psi (1 MPa). Mineral oils of viscosity grades ISO VG 46, ISO VG 68, ISO VG 100 with anti-wear and mild extreme pressure (EP) additives are used for the sliding vane compressors. Synthetic oils of equivalent viscosity indexes (polyalphaolefin, diester, polyglycol synthetics) are recommended for compressors with increased discharge temperature.

### CENTRIFUGAL COMPRESSOR

Centrifugal compressor uses centrifugal force of an impeller rotating at high speed (up to 20000 RPM). Bearings of centrifugal compressors are lubricated by oils of viscosity grades ISO VG 32 ISO or VG 46 (for increased ambient temperatures) with anti-wear additives.

### ROTARY LOBE COMPRESSOR

Rotary lobe compressor consists of two lobes mounted in a housing. When the lobes rotate they compress air between them. Lobe compressors are lubricated by mineral oils from the viscosity range ISO VG 68 to ISO VG 220 with rust and oxidation (R&O) additives and anti-foaming agents. Higher viscosity indexes are used for higher temperatures. For some applications synthetic lubricants of equivalent viscosity indexes are recommended.

## COMPROL-VDL

COMPROL-VDL is a mineral oil specially developed for using in air compressors . The product is a blend of top quality mineral oil plus selected additives to provide excellent thermal stability.

### FEATURES AND BENEFITS

- Excellent water separation properties
- Excellent anti-oxidation & rust protection properties
- Low vapor pressure and volatility
- Excellent resistance to foam forming

### PHYSICAL CHARACTERISTICS

TECHNICAL CHARACTERISTICS	TEST METHOD	VDL 32	VDL 46	VDL 68	VDL 100	VDL 150
ISO VG		VDL 32	VDL 46	VDL 68	VDL 100	VDL 150
Density @15°C, kg/m <sup>3</sup>	ASTM D-1298	910±30	910±30	910±30	910±30	910±50
Viscosity @40°C,	ASTM D-445	32±2	46±4	68±6	100±10	150±15
Viscosity Index	ASTM D-2270	>100	>100	>100	>95	>95
Flash Point, °C	ASTM D-92	>200	>210	>230	>230	>230
Pour Point, °C	ASTM D-97	-18	-18	-18	-18	-18
Copper Strip Corrosion, 3hrs@100°C	ASTM D-130	1b	1b	1b	1b	1b
FZG Gear Test, Failure Stage	DIN 51354	>10	>10	>10	>10	>10
Rust Characteristics	ASTM D665 B	PASS	PASS	PASS	PASS	PASS

Test Method ASTM - Typical test data are average values only. Minor variations, which do not affect performance, may occur.

**Notice: Above specifications can be adjusted to customer's request**

## COMPROL-VDLS

COMPROL-VDLS is a full synthetic oil specially developed for using in air compressors. The product is a blend of top quality synthetic oil plus carefully selected additives to provide outstanding thermal stability and enhanced pour point and viscosity index.

### FEATURES AND BENEFITS

- Outstanding anti-oxidation properties
- Excellent water separation properties
- Low vapor pressure and volatility
- Longer service intervals and improved pour point & VI
- Outstanding resistance to foam forming
- Enhanced RBOT parameter

### PHYSICAL CHARACTERISTICS

TECHNICAL CHARACTERISTICS	TEST METHOD	VDL 32	VDL 46	VDL 68	VDL 100	VDL 150
ISO VG		VDL 32	VDL 46	VDL 68	VDL 100	VDL 150
Density @15°C, kg/m <sup>3</sup>	ASTM D-1298	850±20	850±20	850±20	850±20	850±20
Viscosity @40°C,	ASTM D-445	32±3	46±4	68±6	100±1	150±15
Viscosity Index	ASTM D-2270	>135	>140	>140	>140	>140
Flash Point, °C	ASTM D-92	200	210	210	220	230
Pour Point, °C	ASTM D-97	-50	-50	-40	-40	-40
Copper Strip Corrosion, 3hrs@100°C	ASTM D-130	1b	1b	1b	1b	1b
FZG Gear Test, Failure Stage	DIN 51354	>10	>10	>10	>10	>10
Rust Characteristics	ASTM D665 B	PASS	PASS	PASS	PASS	PASS

Test Method ASTM - Typical test data are average values only. Minor variations, which do not affect performance, may occur.

**Notice: Above specifications can be adjusted to customer's request**

## GEAR OIL

### SYNTHETIC GEAR OIL APPLICATIONS

Synthetic gear oils offer some very real advantages in some circumstances. For example, in extremely low temperatures, a synthetic gear oil will have a much lower viscosity in comparison with equivalent grade of mineral oil. This can be an advantage during cold temperature start-up when channeling can cause temporary lubrication starvation, particularly in splash-lubricated gear drives. Similarly at higher operating temperatures caused by high ambient temperatures or the process itself, synthetic gear oils will have a higher viscosity than the equivalent grade of mineral oil and will typically resist oxidative and thermal breakdown better than mineral oil. A rule of thumb is to use a mineral oil if the operating temperature is below 160 degrees Fahrenheit, but consider synthetics or premium mineral-based oils (such as Group III gear oils) if the operating temperature is likely to exceed 180 F. Also there are other applications of synthetic oil such as for extended oil drain or other operational reasons.

When using synthetic gear oils, pay close attention to the type of synthetic in use. Many synthetic gear oils are made from polyalphaolefin (PAO) basestocks, which are compatible with conventional mineral oils. However, we increasingly see the use of polyglycol gear oils, which have excellent lubricity while helping to keep the gearbox clean of deposits due to their clean-burning and natural detergency tendency. In fact, some gear manufacturers are factory-filling their boxes with polyglycol-based oils. Polyglycols are incompatible with hydrocarbon basestocks (mineral or PAO synthetic), thus requiring extreme caution in helping to prevent accidental mixing and cross-contamination. When switching from a hydrocarbon oil to a polyglycol, perform a thorough cleaning and flushing to help prevent hydrocarbon residues from reacting with the polyglycol gear oil.

### VISCOSITY

Viscosity is of primary importance when selecting gear oils, as it significantly determines the formation of a lubricant film.

Increasing viscosity of the lubricating oil results in thicker lubricant films, thus improving the antiwear and damping properties as well as scuffing load capacity.

Viscosity decreases with increasing temperature and rises with increasing load. If the viscosity is too high, increased churning and squeezing losses can result in excessive heat, especially at elevated peripheral speeds. If the viscosity is too low, mixed friction conditions prevail and will result in increased wear.

Viscosity is highly influenced by temperature. The change in viscosity with temperature is usually determined by means of the viscosity index (VI). The higher the VI of a gear oil, the less viscosity changes with temperature, i.e. the flatter the VT (viscosity-temperature) curve.

The degree to which viscosity changes with temperature depends on the base oil type, such as mineral oil, polyalphaolefin, ester, polyglycol, as well as on the VI improver additives contained in the lubricant.

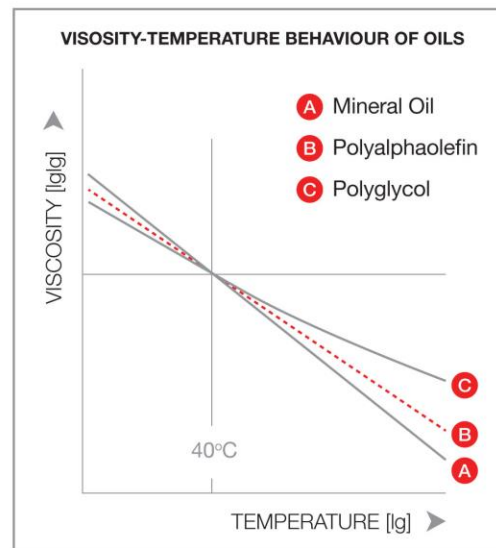

Comparison of viscosity indexes:

Mineral Oil	VI	approx. 85 to 100
Polyalphaolefin	VI	approx. 130 to 160
Polyglycol	VI	approx. 150 to 260

**HINT:**

A high viscosity index facilitates start-up at low outside temperatures, reduces power loss to a minimum and enables the formation of a load-carrying lubricant film also at high temperatures.

## AGEING BEHAVIOUR

An oil's chemical structure continuously changes when it is subjected to high temperatures, mixed with air or in contact with metal catalysts like copper, iron and others, causing it to age. The speed of the ageing process primarily depends on the oil's structure and the amount and duration of heat to which the oil is subjected. Also, contaminants like water, rust or dust contribute to oil ageing. By adding special additives the lubricant manufacturer can retard the ageing process effectively.

Oil ageing is indicated by a change in viscosity, formation of acids enhancing corrosion and residues. Residues caused by ageing occur in the form of lacquer, sludge or gum, which may clog oil lines, injection nozzles and filters. Ageing has a negative effect on the oil's demulsifying capacity, its foaming behaviour, its anticorrosion and wear protection, and, to a certain extent, its air shedding capacity: The ageing behaviour of oils is determined according to ASTM D 2893. If the gear unit is filled with mineral oil, the lubricant should be replaced at least after every 10,000 operating hours or after every two years. If the gear unit is filled with synthetic oil, the lubricant should be replaced at least after every 20,000 operating hours or after every four years. Often gear reducers are exposed to extreme ambient conditions, hostile environments, wet conditions, or dirty and dusty operating areas. Especially in these situations, it is important to establish a condition-based oil service interval.

### HINT:

Synthetic oils show significantly better ageing resistance than mineral oils under comparable operating conditions, which is why they achieve longer oil change intervals.

## LOW-TEMPERATURE BEHAVIOUR

Depending on the base oil type, lubricating oils solidify at low temperatures as their viscosity increases, or due to waxcrystallisation of the contained paraffins.

An oil's pour point is indicative of its cold flow behaviour, which is determined according to ISO 3016. The pour point is the lowest temperature at which the oil still flows when it is cooled down under specified test conditions. In order to ensure rapid and sufficient lubricant supply during a cold start, the lowest temperature occurring in a gear (starting temperature) should always be several degrees above the pour point.

Synthetic gear oils show a much better cold flow behaviour than mineral oils. Due to their high viscosity index (VI), synthetic oils are less viscous at lower temperatures than mineral oils with the same nominal viscosity. Their pour point is much lower, sometimes even below  $-50\text{ }^{\circ}\text{C}$ .

### HINT:

Due to their good cold start behaviour, synthetic gear oils are particularly suitable for very low temperatures.

## EQUIPMENTS

- Steel gear transmissions
- Industrial gear drives where a full EP performance is required
- Bearings
- Enclosed industrial worm gear systems
- Steam cylinder lubrication
- Enclosed industrial gear systems
- Highly loaded gears
- Suitable for lubrication of bearings and other components in circulating and splash-lubricated systems.
- For highly-loaded worm drives
- Worn or damaged gears

- Synthetics type used for: Enclosed Industrial worm gear systems: Recommended for industrial worm gear reduction systems operating under severe operating conditions, such as high load, very low or elevated temperatures and wide temperature variations. Motosel Full synthetic gear oil is particularly recommended for certain systems where maintenance is infrequent or systems are inaccessible (e.g. yaw gears in wind turbine installations).
- Wind turbines and other inaccessible installation
- Recommended for industrial reduction gear systems operating under severe operating conditions, such as high load, very low or elevated temperatures and wide temperature variations.

## SUNOL

SUNOL is a high performance gear oil formulated with various kinds of high quality mineral base oils plus special package additives. This product can be applied to industrial helical, spur, and bevel enclosed gears with circulation or splash lubrication with special conditions. They are specifically suitable for gear sets working under heavy or shock loads. SUNOL also is recommended to be used in marine gearing applications. They may also be used in non-gear applications including rolling contact bearings, highly loaded and slow speed plain. SUNOL is applicable to steel, cement and related industries.

### FEATURES AND BENEFITS

- Extended gear life
- Excellent thermal stability
- High anti-oxidation properties
- Enhanced extreme pressure (EP) with anti - wear properties
- Channeling resistance at low temperatures
- Excellent demulsibility and resistance to foam forming

## SUNOL-S

SUNOL-S is a high performance gear oil formulated with various kinds of high quality synthetic base oils plus special package additives.

### FEATURES AND BENEFITS

- Extended gear lifetime
- Excellent thermal stability
- High anti-oxidation properties
- Outstanding pour point & VI parameters
- Channeling resistance at low temperatures
- Excellent demulsibility and resistance to foam forming
- Enhanced extreme pressure (EP) with anti-wear properties is a high performance gear oil formulated with various kinds of high quality synthetic base oils plus special package additives.

### PHYSICAL CHARACTERISTICS

TECHNICAL CHARACTERISTICS	TEST METHOD	68	100	150	220	320	460	680
ISO		68	100	150	220	320	460	680
Kinematic Viscosity @40°C, cSt	ASTM D-445	68±6	100±10	150±15	220±20	320±30	460±40	680±50
Viscosity Index	ASTM D-2270	>95	>95	>95	>95	>95	>95	>100
Pour Point, °C	ASTM D-97	>-21	>-18	>-18	>-18	>-15	>-9	>-9
Flash Point, °C	ASTM D-92	>190	>200	>200	>200	>210	>210	>210
Density @15°C, kg/m <sup>3</sup>	ASTM D-1298	860±30	860±30	860±30	860±30	860±30	870±30	870±30
Timken OK Load, lb	ASTM D-2782	65	65	65	65	65	65	65
4-Ball EP test	ASTM D-2783							
Weld Load, kg		200	200	200	200	200	200	200
Load Wear Index, kgf		46	46	46	46	46	46	46
FZG Gear Test, Failure Stage	DIN 51354	≥12	≥12	≥12	≥12	≥12	≥12	≥12
Rust protection, Sea Water	ASTM D-665	PASS	PASS	PASS	PASS	PASS	PASS	PASS
Copper Strip Corrosion, 3hrs@100°C	ASTM D-130	1b	1b	1b	1b	1b	1b	1b
Demulsibility @82°C	ASTM D-1401	30	30	30	30	30	30	30
Time to 3ml emulsion, minutes (max)								
Foam Test, Tendency/Stability, ml/ml Sequence I	ASTM D-892	10/0	10/0	10/0	10/0	10/0	10/0	10/0
Foam Test, Tendency/Stability, ml/ml Sequence II	ASTM D-892	30/0	30/0	30/0	30/0	30/0	30/0	30/0

Test Method ASTM - Typical test data are average values only. Minor variations, which do not affect performance, may occur.

Notice: Above specifications can be adjusted to customer's request

### PHYSICAL CHARACTERISTICS

TECHNICAL CHARACTERISTICS	TEST METHOD	150	220	320	460	680	1000
ISO		150	220	320	460	680	1000
Kinematic Viscosity @40°C, cSt	ASTM D-445	150±5	220±10	320±15	460±20	680±32	1000±50
Viscosity Index	ASTM D-2270	>140	>140	>140	>140	>140	>140
Pour Point, °C	ASTM D-97	≤-45	≤-40	≤-30	≤-30	≤-27	≤-24
Flash Point, °C	ASTM D-92	>220	>220	>226	>230	>240	>240
Density @15°C, kg/m <sup>3</sup>	ASTM D-1298	850±50	850±50	850±50	860±50	870±50	870±50
Appearance	Visual	Orange	Orange	Orange	Orange	Orange	Orange
TOST, mod, hrs.	ASTM D-943	10000+	10000+	10000+	10000+	10000+	10000+
RPVOT, minutes	ASTM D-2272	2500	2500	2500	2500	2500	2500
Rust protection, Synthetic Sea Water	ASTM D-665B	PASS	PASS	PASS	PASS	PASS	PASS
Water Separability, Min. to 37ml water @54°C	ASTM D-1401	-	-	-	-	-	-
Water Separability, Min. to 37ml water @82°C	ASTM D-1401	20	20	20	20	20	25
Copper Strip Corrosion, 3hrs@100°C	ASTM D-130	1b	1b	1b	1b	1b	1b
Foam Test, Tendency/Stability, ml/ml Sequence I	ASTM D-892	0/0	0/0	0/0	0/0	0/0	0/0
Foam Test, Tendency/Stability, ml/ml Sequence II	ASTM D-892	0/0	0/0	0/0	0/0	0/0	0/0
Foam Test, Tendency/Stability, ml/ml Sequence III	ASTM D-892	0/0	0/0	0/0	0/0	0/0	0/0
FZG Gear Test, Failure Stage	DIN 51354	≥12	≥12	≥12	≥12	≥12	≥12

Test Method ASTM - Typical test data are average values only. Minor variations, which do not affect performance, may occur.

Notice: Above specifications can be adjusted to customer's request

## NAS VALUE

Gearbox applications present many challenges when it comes to achieving and maintaining an aggressive level of oil cleanliness. A balance must be maintained between what is financially feasible to achieve and what is absolutely best for the machine. It has been estimated that it can cost nearly 10 times more to remove contamination than what it takes to keep contamination out in the first place. In order to keep contamination out of our gearboxes, we must consider the technologies that are available on the market today. One of the most common types of contamination control devices for gearboxes is the breather. It is common for a gearbox to be sent by default from the manufacturer with a simple vent port/plug. NAS value of Motosel gear oils are from 7 to 8 for all available grades.

## OPERATING TEMPERATURE

The oil temperature in industrial gears is between 20 and 150 °C, depending on the type of gear and the application. Heating of a gear system, in particular of the gear wheels, bearings and the lubricant, is one of the most important criteria to evaluate the gear's performance. The existing temperatures are indicative of the power losses. Apart from design-related influences, oil temperatures mainly depend on the operating conditions. Oil temperatures rise with an increasing ambient temperature and when the oil is exposed to thermal radiation. They do not become quite as high when the gear is operated under partial load conditions or intermittently. It is important to ensure that the permissible temperature limits are not exceeded in individual gear components, the lubricant and the accessories (filters, pumps etc.). For viscosity selection, the oil sump temperature or temperature of the injected oil is an important factor. Operating temperatures above average or temperature peaks often indicate malfunctions or incipient damage.

## FOAMING BEHAVIOUR

Gear oils should be able to separate dispersed air rapidly and prevent the formation of stable surface foam. Foam is generated by air bubbles rising to the surface. The bubbles should burst as quickly as possible to keep foam to a minimum. Particularly in case of splash-lubricated gears operating at medium to high peripheral speeds, the oil has a pronounced foaming tendency due to the air constantly introduced. Contaminants such as water, dust, corrosion particles and ageing residues may even increase the foaming tendency. Foaming has a strong negative impact on the lubricant's properties, such as oxidation stability, heat dissipation, etc. Excessive foaming may cause the foam to be forced out of the breather vent; in case of force-feed lubrication there is the danger of foam being drawn into the oil pump causing noise or damage. The oil manufacturer can reduce the foaming tendency by adding anti-foam additives. However, too high a concentration may affect the air shedding capacity. The foaming tendency of a lubricating oil is determined according to ISO 6247 or ASTM D 892. A more practice-oriented approach is the Flender foam test according to ISO 12152, which is increasingly gaining in importance. In this test, the gear pair runs in the oil, thus entraining air into the oil. Then the oil is checked for air absorption, formation of oil-air dispersion, surface foam and the degree to which these phenomena are reversible.

## SELECTION OF THE RIGHT GEAR OIL

Mineral or synthetic gear oils Today, many enclosed industrial gearboxes are still lubricated with mineral oils. Where these oils come up against their limitations, e.g. in terms of operating temperatures, the use of synthetic gear oils should be considered. Gear lubricants based on the following.

- polyalphaolefin (PAO)
- polyglycol (PG)
- ester (E)

## POLYALPHAOLEFINS (PAO)

Polyalphaolefins have a chemical structure similar to mineral oils. They are therefore generally known under the designation synthetic hydrocarbons (SHC). Their compatibility with seal materials and paints is comparable to that of mineral oils. They should be disposed of or reprocessed in the same way as mineral oils and are miscible with mineral oil residues. Selected PAO base oils and corresponding additives may also be used for the manufacture of physiologically safe gear lubricants (H1 oils\*) for use in the food-processing and pharmaceutical industries. Gear oils based on PAO show good oxidation resistance, enabling much longer oil change intervals. They also show especially good low-temperature behaviour.

## POLYGLYCOLS (PG)

With polyglycol oils, very low friction results can be attained, which is why they are preferably used for the lubrication of gears with a high proportion of sliding friction, e.g. worm and hypoid gears. When combined with corresponding additives, they show excellent antiwear behaviour, especially in steel/bronze worm gears. Just like gear oils based on PAO, oils based on specific polyglycols and additives may be used for the manufacture of physiologically safe gear lubricants (H1 oils\*) for use in the food-processing and pharmaceutical industries. Polyglycols are miscible with mineral oils to a limited extent only, so mixing should be avoided. Because of their high resistance to oxidation, polyglycols are often used at extremely high gear temperatures.

## ESTERS (E)

Synthetic ester oils are compounds of acids and alcohols. Innumerable different ester structures are therefore possible, each with different chemical and physical characteristics and giving rise to different lubricant properties. Depending on the individual type, ester oils may show particularly good thermal resistance or a particularly good low-temperature behaviour. The ester oils used in industrial gears are normally of the rapidly biodegradable type. Their performance is generally comparable with that of polyalphaolefin or polyglycol oils. Esters are miscible with mineral oils and polyalphaolefins. Mixing with polyglycols is possible to a limited extent only.



## OIL LIFE TIME

The prolonged service life of synthetic lubricants and the consequent longer oil change intervals can reduce equipment downtime and save resources. In some cases, lubrication for-life is possible.

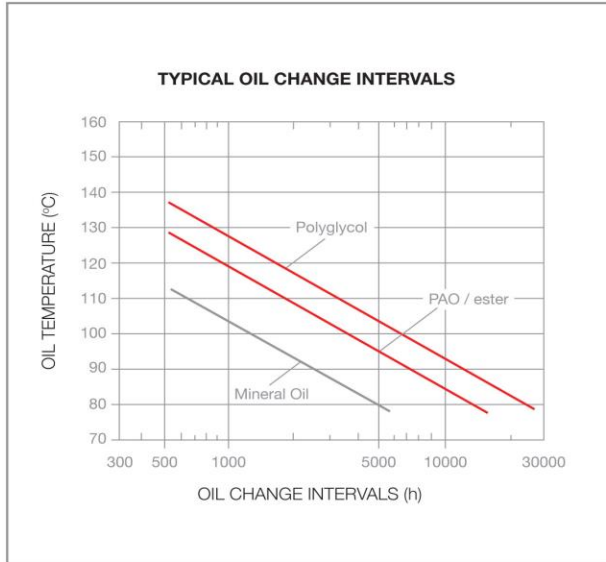

## TURBINE OIL

Every part of your machine or process has been meticulously engineered, so you want to use a lubricant that has been designed to ensure that your equipment is well protected and works efficiently. The Motosel Turbo range of turbine oils has been developed to enable equipment operators to select the oil that will deliver optimum value to their operations through wear protection and long oil life system efficiency.

Motosel Turbine Oil is a high-quality, rust and oxidation (R&O)-inhibited circulating oil developed for use in industrial steam turbines, rotary air compressors and many other industrial applications. Turbine Oil is available in four viscosity grades: ISO 32, 46, 68 and 100. It is formulated with high-quality paraffinic base oils and select additives to provide excellent oxidation resistance, protection against rust and corrosion, and resistance to foaming. It has excellent oxidation resistance and thermal stability at high temperatures to minimize sludge and varnish formation, and provide long service life. It protects system components against rust and corrosion. It has excellent water-separating properties to minimize the formation of emulsions, and is resistant to excessive foam buildup that can interfere with proper lubrication.

This figure shows the effect on the overall cycle efficiency of the increasing pressure ratio and the firing temperature. The increase in the pressure ratio increases the overall efficiency at a given temperature, however increasing the pressure ratio beyond a certain value at any given firing temperature can actually result in lowering the overall cycle efficiency. The limiting factor for most gas turbines has been the turbine inlet temperature. With new schemes for cooling using steam or conditioned air, and breakthroughs in blade metallurgy, higher turbine temperatures have been achieved.

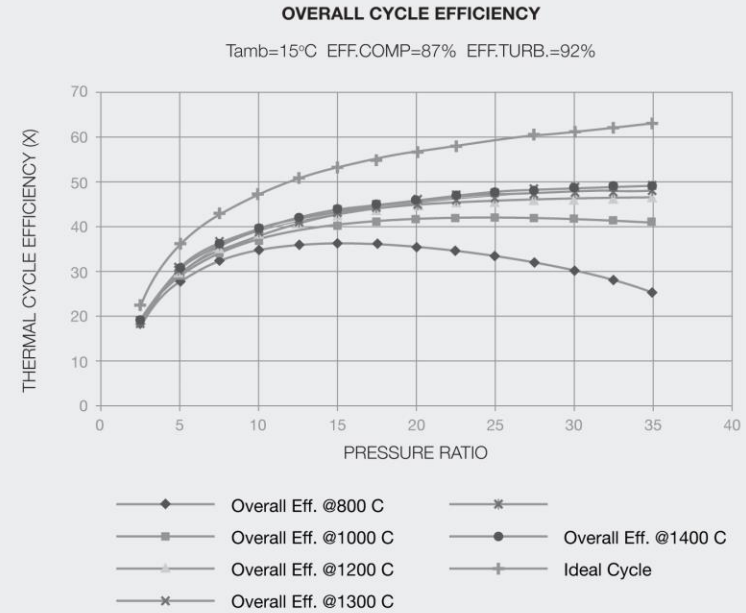

## VARNISH IN TURBINE OILS

The appearance of varnish in turbine oil can lead to hydraulic malfunctions and to increased bearing temperatures. The consequences are unplanned downtimes and high costs. Varnish are oil aging products that form gel-, resin-like or solid varnish-like deposits in the fluid system. Among other things the reason for these deposits is the limited dissolution capacity of varnish in modern turbine oils. Furthermore, these oils also have low electrical conductivity, which causes electrostatic discharges in the system. This results in accelerated oil aging and damage. To sensors and filter elements. In the past an oil fill had a service life of usually 15 to 20 years. Today the service life of modern oils is significantly less than ten years. In order to avoid critical system operation, the routine laboratory examination parameters must be expanded. Early recognition of the risk of deposits and the use of adapted fluid care will increase the safety of operations and reduce operating costs.

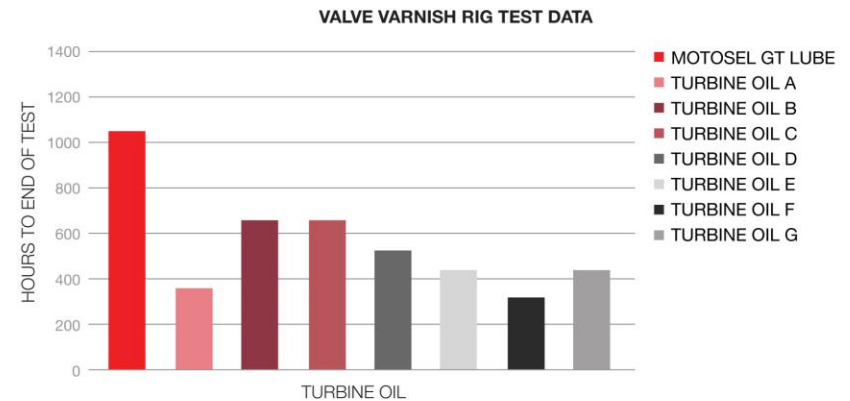

## MOTOSEL TURBINE OIL FORMULATIONS FOR ALL TYPES OF TURBINES

Motosel has created unique blends of gas turbine oil, steam turbine oil and hydroelectric turbine oil to protect the parts of even the most high-maintenance machines. Whether your business relies on mainline / baseload turbines or peaking turbines. Motosel's premium turbine oils will inject new life into your equipment, relieving it of excessive temperatures and enabling it to bear heavy loads with greater ease. Motosel turbine oils are available for units driven with or without reduction gears in a variety of ISO viscosity grades ISO 32, ISO 46 and ISO 68.

## MOTOSEL TURBINE OILS PROTECT LONG-SERVICE-LIFE EQUIPMENT

Motosel's versatile turbine oils meet or exceed original equipment manufacturer requirements for many turbines, generators and governors. By fighting off many other common causes of equipment damage, Motosel turbine oils provide maximum value for long-service-life applications such as circulating oil systems, centrifugal compressors and turbine bearings.

You can rely upon Motosel's gas turbine, steam turbine and hydroelectric turbine oils to provide long-lasting performance, excellent water separation, R & O resistance, nonfoaming performance, resistance to varnish and sludge formation.

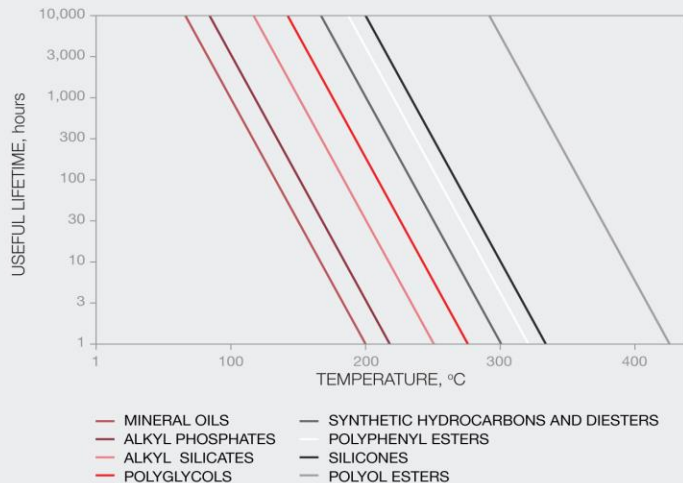

## TURBINE OILS ARE ENVIRONMENTALLY FRIENDLY OPTION

In addition, Turbine Oils feature low ecotoxicity for environmentally sensitive applications. They reduce environmental impact – as compared to other commercial turbine oils and biodegradable oils – while still providing outstanding wear protection and temperature reduction. That is especially valuable if your operation includes hydroelectric dams, forestry equipment, paper mills, water pumps or wastewater treatment equipment. You can protect your equipment – and your environment – with Turbine Oil.

## SYNTHETIC ADVANTAGE

The premium quality turbine Motosel oils are developed to lubricate steam, water and gas turbines. These turbine oils exhibit superior oxidation stability demonstrated by more than 700 hours in rbot test, as well as good corrosion protection and antiwear properties. Motosel turbine oils are also suitable for the lubrication of the associated with turbines equipment and assemblies and as well as the systems governing them.

Baths and circulating systems, oil-lubricated bearings of different types, from moderately to medium loaded assemblies and hydraulic systems under low to moderate pressures are among the other typical applications. The improved corrosion performance in synthetic sea water makes these turbine oils suitable for application in on-board compressors and turbines in different vessels as well as other auxiliary equipment.

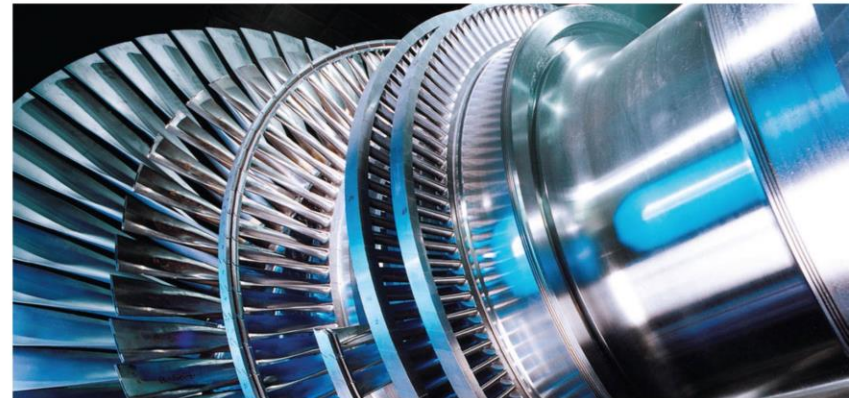

## TURBEX

TURBEX is a high performance multipurpose mineral turbine oil which is produced from high quality mineral base oils and several kinds of special additives.

### FEATURES AND BENEFITS

- Excellent anti-oxidation properties
- Enhanced RBOT parameter
- Enhanced resistance to foam forming
- Excellent shear stability and anti-corrosion performance
- Superior demulsibility properties

### PHYSICAL CHARACTERISTICS

TECHNICAL CHARACTERISTICS	TEST METHOD	TURBEX 32	TURBEX 46	TURBEX 68	TURBEX 100
ISO VG					
Appearance	Visual	Clear	Clear	Clear	Clear
Density@ 20°C, kg/m <sup>3</sup>	ASTM D-1298	850±50	850±50	850±50	850±50
Viscosity @40°C, cSt	ASTM D-445	32±3	46±4	68±6	100±10
Viscosity Index	ASTM D-2270	>95	>95	>95	>95
Flash Point, °C	ASTM D-92	>200	>206	>210	>220
Pour Point, °C	ASTM D-97	<-18	<-18	<-18	<-18
Total Acid Number, mgKOH/g	ASTM D-661	0.1 max	0.1 max	0.1 max	0.1 max
Copper Strip Corrosion, 3 hrs.@100 °C	ASTM D-130	1b max	1b max	1b max	1b max
Foam Test, Sequence I, ml/ml	ASTM D-892	10/0	10/0	10/0	10/0

Test Method ASTM - Typical test data are average values only. Minor variations, which do not affect performance, may occur.

**Notice: Above specifications can be adjusted to customer's request**

## TURBEX S5

TURBEX S5 is a fully synthetic high quality lubricants designed to be used as a turbine lubricants. This produced has an extremely good wear -inhibiting capability, which provides long life time of the turbine.

### FEATURES AND BENEFITS

- Excellent anti-oxidation properties and enhanced RBOT parameter
- Excellent shear stability and anti-corrosion performance
- Superior demulsibility properties and enhanced resistance to foam forming

### PHYSICAL CHARACTERISTICS

TECHNICAL CHARACTERISTICS	TEST METHOD	ISO VG
ISO VG		TURBEX-S5
Color	Visual	Yellow
Appearance	Visual	Clear
Density@ 15.6°C, kg/m <sup>3</sup>	ASTM D-1298	950±55
Viscosity @40°C, cSt	ASTM D-445	26-32
Viscosity @100°C, cSt	ASTM D-445	5±1
Flash Point, °C	ASTM D-92	>250
Pour Point, °C	ASTM D-97	<-54
Copper Strip Corrosion, 3 hrs.@100 °C	ASTM D-130	1a
Foam Test, Sequence I, ml/ml	ASTM D-892	20/0
Water Content	ASTM D-1533	Nil

Test Method ASTM - Typical test data are average values only. Minor variations, which do not affect performance, may occur.

**Notice: Above specifications can be adjusted to customer's request**

## TURBEX F46

TURBEX F46 is a fully synthetic high quality lubricant designed to be used as a turbine lubricant. This product has an extremely good wear-inhibiting capability, which provides long life time of the turbine.

### FEATURES AND BENEFITS

- Excellent shear stability and anti-corrosion performance
- Excellent anti-oxidation properties and enhanced RBOT parameter
- Superior demulsibility properties and enhanced resistance to foam forming

### PHYSICAL CHARACTERISTICS

TECHNICAL CHARACTERISTICS	TEST METHOD	ISO VG
ISO VG		TURBEX-F46
Color	Visual	Yellow
Appearance	Visual	Clear
Density@ 20°C, kg/m <sup>3</sup>	ASTM D-1298	1130±20
Kinematic Viscosity @40°C, cSt	ASTM D-445	51±5
Kinematic Viscosity @100°C, cSt	ASTM D-445	5-6
Flash Point, °C	ASTM D-92	>250
Acid Value, mgKOH/g	ASTM D-644	0.04
Water Content, wt%	ASTM D-1533	<0.1
Ignition Point, °C	ASTM D-92	>365
Auto-Ignition temperature	ASTM D-659	>560
Foam Test, Sequence I, ml/ml	ASTM D-892	10/0

Test Method ASTM - Typical test data are average values only. Minor variations, which do not affect performance, may occur.

**Notice: Above specifications can be adjusted to customer's request**

## KNOW MORE ABOUT TURBINE TYPES

A well-maintained steam turbine oil with moderate makeup rates should last 20 to 30 years. When a steam turbine oil fails early through oxidation, it is often due to water contamination. Water reduces oxidation stability and supports rust formation, which among other negative effects, acts as an oxidation catalyst. Varying amounts of water will constantly be introduced to the steam turbine lubrication systems through gland seal leakage. Because the turbine shaft passes through the turbine casing, low pressure steam seals are needed to minimize steam leakage or air ingress leakage to the vacuum condenser. Condensed steam is generally channeled away from the lubrication system, but inevitably some water will penetrate the casing and enter the lube oil system. Gland seal condition, gland sealing steam pressure, and the condition of the gland seal exhauster will impact the amount of water introduced to the lubrication system. Typically, vapor extraction systems and high-velocity downward flowing oil create a vacuum, which can draw steam past shaft seals into the bearing and oil system. Water can also be introduced through lube oil cooler failures, improper powerhouse cleaning practices, water contamination of make up oil, and condensed ambient moisture. In many cases, the impact of poor oil-water separation can be offset with the right combination and quality of additives including antioxidants, rust inhibitors, and demulsibility improvers. Excess water may also be removed on a continuous basis through the use of water traps, centrifuges, coalescers, tank headspace dehydrators, and/or vacuum dehydrators. If turbine oil demulsibility has failed, exposure to water-related lube oil oxidation is then tied to the performance of water separation systems.

Heat will also cause reduced turbine oil life through increased oxidation. In utility steam turbine applications, it is common to experience bearing temperatures of 120°F to 160°F (49°C to 71°C) and lube oil sump temperatures of 120°F (49°C). The impact of heat is generally understood to double the oxidation rate for every 18 degrees above 140°F (10 degrees above 60°C). A conventional mineral oil will start to rapidly oxidize at temperatures above 180°F (82°C). Most tin babbited journal bearings will begin to fail at 250°F (121°C), which is well above the temperature limit of conventional turbine oils. High-quality antioxidants can delay thermal oxidation, but excess heat and water must be minimized to gain long turbine oil life.

## AERO-DERIVATIVE GAS TURBINES

Aero-derivative gas turbines present unique turbine oil requirements that call for much higher oxidatively stable lubricating oils. Of primary concern is the fact that the lube oil in aero-derivative turbines is in indirect contact with metal in temperatures of 400°F to 600°F (204°C to 316°C). Sump lube oil temperatures can range from 160°F to 250°F (71°C to 121°C). These compact as turbines utilize the oil to lubricate and to transfer heat back to the lube oil sump. In addition, their cyclical operation imparts significant thermal and oxidative stress on the lubricating oil. These most challenging conditions dictate the use of high purity synthetic lubricating oils. Average lube oil make up rates of 15 gallons per hour will help rejuvenate the turbo oil under these difficult conditions. Current technology turbine oils for Aero-derivative, land-based power generation turbines are described as 5cSt turbo oils. Aero-derivative turbines operate with much smaller lube oil sumps, typically 50 gallons or less. The turbine rotor is run at high speeds, 8,000 to 20,000 rpm, and is supported by roller element bearings.

## GAS TURBINES

For most large gas turbine frame units, high operating temperature is the leading cause of premature turbine oil failure. The drive for higher turbine efficiencies and firing temperatures in gas turbines have been the main incentive for the trend toward more thermally robust turbine oils.

Today's large frame units operate with bearing temperatures in the range of 160°F to 250°F (71°C to 121°C). Next-generation frame units are reported to operate in even higher temperature ranges. Gas turbine OEMs have increased their suggested limits on RPVOT—ASTM D2272 (Rotation Pressure Vessel Oxidation Test) and TOST—ASTM D943 (Turbine Oil Oxidation Stability) performance to meet these higher operating temperatures. As new-generation gas turbines are introduced into the utility market, changes in operating cycles are also introducing new lubrication hurdles. Lubrication issues specific to gas turbines that operate in cyclic service started to appear in the mid-1990s.

## HYDRO TURBINES

Hydro turbines typically operated on ISO46 or 68 R&O oils. Demulsibility and hydrolytic stability are the key performance parameters that impact turbine oil life due to the constant presence of water. Ambient temperatures swings in hydro electric service also make viscosity stability, as measured by viscosity index, an important performance criterion.

OUTSTANDING OXIDATION STABILITY  
& EXTREME ANTIFOAMING  
PROPERTIES

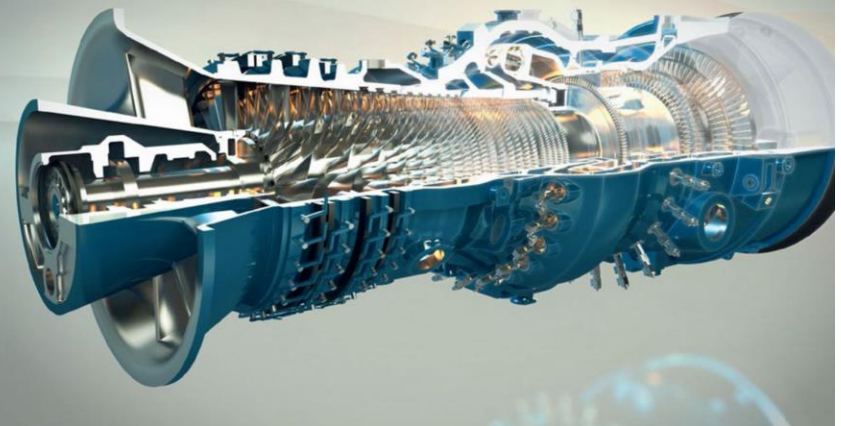

## WIND TURBINE OIL

### MOTOSEL BIO

#### DESCRIPTION

High performance EAL for enclosed gears.

#### APPLICATIONS

MOTOSEL BIO is a new generation high performance EAL lubricant developed for gear and bearing lubrication. MOTOSEL BIO is designed to replace mineral gear oils for gearboxes operating in environmentally sensitive areas.

#### PROPERTIES

MOTOSEL BIO has very good extreme pressure properties as premium mineral gear oil and a high scuffing load capacity ensuring good protection of gears operating under high load. The synthetic base oils used combine good lubrication properties and a high oxidation stability. These base oils comply with the European Ecolabel criteria for biodegradability, renewable carbon content and for ecotoxicity. MOTOSEL BIO ensures high corrosion protection, even with sea water contamination, and provides lubrication advantages at both high and low temperatures compared to mineral oils.

#### SPECIFICATIONS

MOTOSEL BIO can be used when CKC/CKD (ISO 12925-1) or CLP (DIN 51517-3) mineral lubricant performance levels are requested. Environmentally Acceptable Lubricant (EAL) for 2013 (VGP)

#### APPROVALS

ZF PROPULSION, WÄRTSILÄ, HHI thrusters, SCANA.



### PHYSICAL CHARACTERISTICS

TECHNICAL CHARACTERISTICS	TEST METHOD	68	100	150	220	320
ISO		68	100	150	220	320
Density@ 15.6°C, kg/m <sup>3</sup>	ISO 3675	960±10	960±10	960±10	960±10	960±10
Viscosity @40°C, cSt	ISO 3104	68±5	100±10	150±10	220±15	320±20
Viscosity @100°C, cSt	ISO 3104					
Viscosity Index	ISO 2909	>145	>145	>145	>145	>145
Flash Point, °C	ASTM D-92	>235	>235	>235	>235	>235
Pour Point, °C	ISO 3016	-42	-42	-30	-27	-24
FZG Gear Test, Failure Stage	DIN 51354	-	≥12	≥12	≥12	≥12
Foam Test, ml/mk	ISO 6614	10/0	10/0	10/0	10/0	10/0

# MOTOSEL SH

## DESCRIPTION

Synthetic oil (PAO) for enclosed gears.

## APPLICATIONS

Enclosed gears, bearings, gear couplings MOTOSEL SH has been developed for enclosed industrial gears to provide optimum gear protection against micropitting and bearing protection against scuffing under very severe conditions.

- bevel and spur gears
- Heavily loaded bearings and gear couplings.

## ADVANTAGES

- Very high protection (high and low temperatures) from micropitting scuffing wear (GFT -class: high).
- Excellent extreme-pressure performance: protection against high loads.
- Very high natural viscosity index: (shear stable) and low friction coefficient.
- Very low pour point: operation at very low temperatures.
- Very good resistance to oxidation: operation at high temperatures, and lifetime increased by a factor of 2 to 4.
- Compatible with seals and metals containing cop.

## SPECIFICATIONS

International specifications Manufacturers

- DIN 51517 Part 3 group CLP
- NF-ISO 6743-6 category CKD
- AISI 224
- CINCINNATI MILACRON
- DAVID BROWN
- FLENDER
- FLENDER
- USINOR FT 161
- MÜLLER WEINGARTEN
- AGMA 9005 - E02



## PHYSICAL CHARACTERISTICS

TECHNICAL CHARACTERISTICS	TEST METHOD	150	220	320	460	680	1000
ISO VG		150	220	320	460	680	1000
Density@ 15.6°C, kg/m <sup>3</sup>	ISO 3675	850±50	850±50	850±50	850±50	850±50	850±50
Kinematic Viscosity @40°C, cSt	ISO 3104	150±10	220±15	320±20	460±30	650±36	1000±100
Viscosity Index	ISO 2909	>150	>150	>150	>160	>160	>160
Flash Point, °C	ISO 2592	>220	>220	>220	>220	>220	>220
Pour Point, °C	ISO 3016	-45	-45	-42	-30	-21	-18
FZG Gear Test, Failure Stage	DIN 51354	≥12	≥12	≥12	≥12	≥12	≥12

# MOTOSEL XEP

## DESCRIPTION

High performance lubricant for enclosed gears.

## APPLICATIONS

Heavily loaded gears in casing:  
MOTOSEL XEP is a new generation of high-performance lubricant for heavily loaded reducers. The severest technical specifications were taken into account during the development of this product especially regarding micropitting protection and anticorrosion properties. The specific MOTOSEL XEP additivation reduces considerably the wears of gears and mechanisms.

## ADVANTAGES

- Excellent extreme-pressure performances, remarkable protection of heavily loaded toothing against micropitting.
- Excellent anti-corrosion properties protecting gears in critical environments (seawater or acidic water contamination).
- Very good thermal stability ensuring a longer service life than conventional lubricants.
- Strengthened foaming protection. Good demulsification behaviour.

## SPECIFICATIONS

International specifications

- DIN 51517 Part 3
- CLP group
- ISO 12925 CKD category
- US STEEL 224
- FLENDER



## PHYSICAL CHARACTERISTICS

TECHNICAL CHARACTERISTICS		TEST METHOD				
		150	220	320	460	680
ISO VG		150	220	320	460	680
Kinematic Viscosity @40°C, cSt	ISO 3104	150±10	220±15	320±20	460±30	650±36
Viscosity Index	ISO 2909	>95	>95	>95	>95	>100
Density@ 15.6°C, kg/m³	ISO 3675	850±50	850±50	850±50	850±50	850±50
Flash Point, °C	ISO 2592	>230	>230	>230	>230	>230
Pour Point, °C	ISO 3016	-18	-18	-15	-12	-12
Bearing West Test	DIN 51819-3	-	<2	<2	<2	<2
FZG Gear Test, Failure Stage	DIN 51354	-	≥12	≥12	≥12	≥12
Foam Test, ml/ml	ISO 6614	0/0	0/0	0/0	0/0	0/0
4-Ball EP Test, kg		-	315	-	-	-
4-Ball Wear Test, mm		-	0.34	-	-	-
Copper Strip Corrosion 3hrs, @100°C	ISO 2160	1b	1b	1b	1b	1b



## MOTOSEL SY WM 320

### DESCRIPTION

Synthetic oil (polyglycol) for enclosed gears.

### APPLICATIONS

Enclosed gears :

- Lubrication of worm gears and gears operating under the most severe conditions (high loads, extreme temperatures).
- The specific performances of this oil make it particularly suitable for use in the gearboxes of the wind Mill.

### FEATURES AND BENEFITS

- Usable in the Food Industries.
- Very high viscosity index: mechanical shear stable.
- High tolerance to contamination by water (water soluble).
- Excellent thermal stability: extended oil lifetime.
- Low coefficient of friction: greater protection for non-ferrous parts, such as the bronze ring gear in worm gears systems, offering an energy saving of between 5 and 10% compared with a mineral oil.
- Excellent extreme pressure and anti-wear properties: highly micropitting resistant (classification: high).

### SPECIFICATIONS

International specifications Manufacturers

- DIN 51517 Part 3 group CLP
- NF-ISO 6743-6 category CKS/CKT
- DAVID BROWN
- FLENDER

### PHYSICAL CHARACTERISTICS

TECHNICAL CHARACTERISTICS	TEST METHOD	MOTOSEL SY WM320
ISO		WM320
Density@ 15°C, kg/m <sup>3</sup>	ISO 3675	1061
Viscosity @40°C, cSt	ISO 3104	320
Viscosity Index	ISO 2909	>250
Flash Point, °C	ISO 2592	>275
Pour Point, °C	ISO 3016	<-30
FZG Gear Test, Failure Stage	DIN 51354	>12

### HANDLING OPERATIONS - HEALTH - SAFETY

- Oils based on POLYGLYCOLS, such as MOTOSEL SY WM, are incompatible with most mineral and synthetic oils (PAO). Similarly, check compatibility with system components (seals and paint).
- For more information regarding safety issues please visit [www.motosel.com](http://www.motosel.com)

## MOTOSEL SY

### DESCRIPTION

Synthetic lubricant for enclosed gears (polyglycol).

### APPLICATIONS

Enclosed gears :

- Lubrication of gears operating under the most severe conditions (high loads, shocks, extreme temperatures and corrosive atmospheres).
- Lubrication of worm gears.

### FEATURES AND BENEFITS

- Very high level corrosion protection (tested with sea and acidic water).
- Excellent thermal stability: extended oil lifetime.
- Low coefficient of friction: greater protection for non-ferrous parts, such as the bronze ring gear in worm gears systems, offering an energy saving of between 5 and 10% compared with a mineral oil.
- Very good foaming behaviour.
- Excellent extreme pressure and anti-wear properties.
- Very high and shear stable viscosity index.

### SPECIFICATIONS

International specifications Manufacturers

- DIN 51517 Part 3 group CLP
- NF-ISO 6743-6 category CKS/CKT
- DAVID BROWN, CMD

### PHYSICAL CHARACTERISTICS

TECHNICAL CHARACTERISTICS	TEST METHOD	150	220	320	460	640
ISO		150	220	320	460	640
Density@ 15°C, kg/m <sup>3</sup>	ISO 3675	1000±5	1000±5	1000±5	1000±5	1000±5
Viscosity @40°C, cSt	ISO 3104	150±10	220±15	320±20	460±30	640±30
Viscosity Index	ISO 2909	>180	>200	>220	>220	>230
Flash Point, °C	ISO 2592	230	230	230	230	230
Pour Point, °C	ISO 3016	<-33	<-30	<-30	<-30	<-30

### HANDLING OPERATIONS - HEALTH - SAFETY

- POLYGLYCOL (or PAG) based lubricants, such as MOTOSEL SY, are incompatible with most mineral and synthetic oils (PAO).
- Compatibility with the gearboxes components (seals, paints ....) must be checked.
- For more information regarding safety issues please visit [www.motosel.com](http://www.motosel.com)

## ELECTROL OIL

### MOTOSEL ELECTROL

Motosel electrol is an uninhibited transformer oil that conforms to IEC 60296 Edition 4.0. Developed and formulated to deliver solid resistance to oil degradation, Motosel electrol provides good oxidation stability thanks to its natural inhibitors. This increases the possibilities for a longer transformer life with less maintenance.

#### DESIGNED FOR HEAVY DUTY

This product has been specially developed for use in oil-filled electrical equipment – including power and distribution transformers, rectifiers, circuit breakers and switch gears.

#### PERFORMANCE AND BENEFITS

Good heat transfer. Thanks to low viscosity and viscosity index, this standard grade offers extremely good heat transfer characteristics, ensuring heat is efficiently removed from core and windings. Reliable oxidation stability. Developed and formulated to deliver good resistance to oil degradation, this grade also provides good oxidation stability for enhanced transformer life and minimum maintenance. Very good low temperature properties. Naphthenic characteristics allow the transformer to start at the lowest possible temperature – without using pour point depressants. High dielectric strength. This insulating oil both meets and exceeds the toughest demands on dielectric strength – when stored and handled correctly.

#### PRODUCT DESCRIPTION

Motosel electrol fulfils the requirements for IEC 60296 Edition 4.0 uninhibited oil. Motosel classifies this product as a standard grade.

Motosel electrol is rigorously analysed and passes the following corrosion tests:

- ASTM D1275 method B
- IEC 62535
- DIN 51353

In accordance with IEC 60296 Edition 4.0, all additives are declared.



## PHYSICAL CHARACTERISTICS

TECHNICAL CHARACTERISTICS	TEST METHOD	
Appearance	IEC 60296	Clear, free from sediment
Kinematic Viscosity @40°C, cSt	ASTM D-445	8-10
Density@ 15°C, kg/m <sup>3</sup>	ISO 12185	850-880
Flash Point, PMC, °C	ISO 2719	150
Pour Point, °C	ISO 3016	<-40
Total Acid Number, mgKOH/g	IEC 62021	<0.05
Water content, ppm	IEC 60814	<30
Breakdown Voltage, kV	IEC 60156	40-60
DDF @90 °C	IEC 60247	<0.01
Interfacial Tension, mN/m	EN 14210	40-50
Corrosive Sulphur	DIN51353	non-corrosive
Oxidation Stability @120, 164h	IEC61125C	
Total Acidity, mg KOH/g		0.57
Sludge, wt%		0.16
PCB	IEC 61619	not detectable

## APPLICATION

Used for all types of oil filled electrical devices including transformers, oil filled switches, circuit breakers and capacitors. Can also be used in submersible pumps with oil filled electric motors requiring dielectric oil.

## BENEFICIAL QUALITIES

- Type II Transformer Oil by ASTM D3487 & Noncorrosive.
- Low pour point gives excellent low temperature properties.
- Excellent heat removal for cooler operation.
- Cooler operation helps extend equipment life.
- Excellent resistance to oxidation for longer life.
- High dielectric breakdown voltage.





**MOTSEL INDUSTRIAL GROUP Inc.**

Suite 407 - 207 Cayer Street  
Coquitlam, BC V3K 5B1, Canada

